

Jan. 7, 1930.

H. A. KLIEGL ET AL

1,742,600

FLOODLIGHT

Filed May 24, 1928

4 Sheets-Sheet 3

FIG. 5.

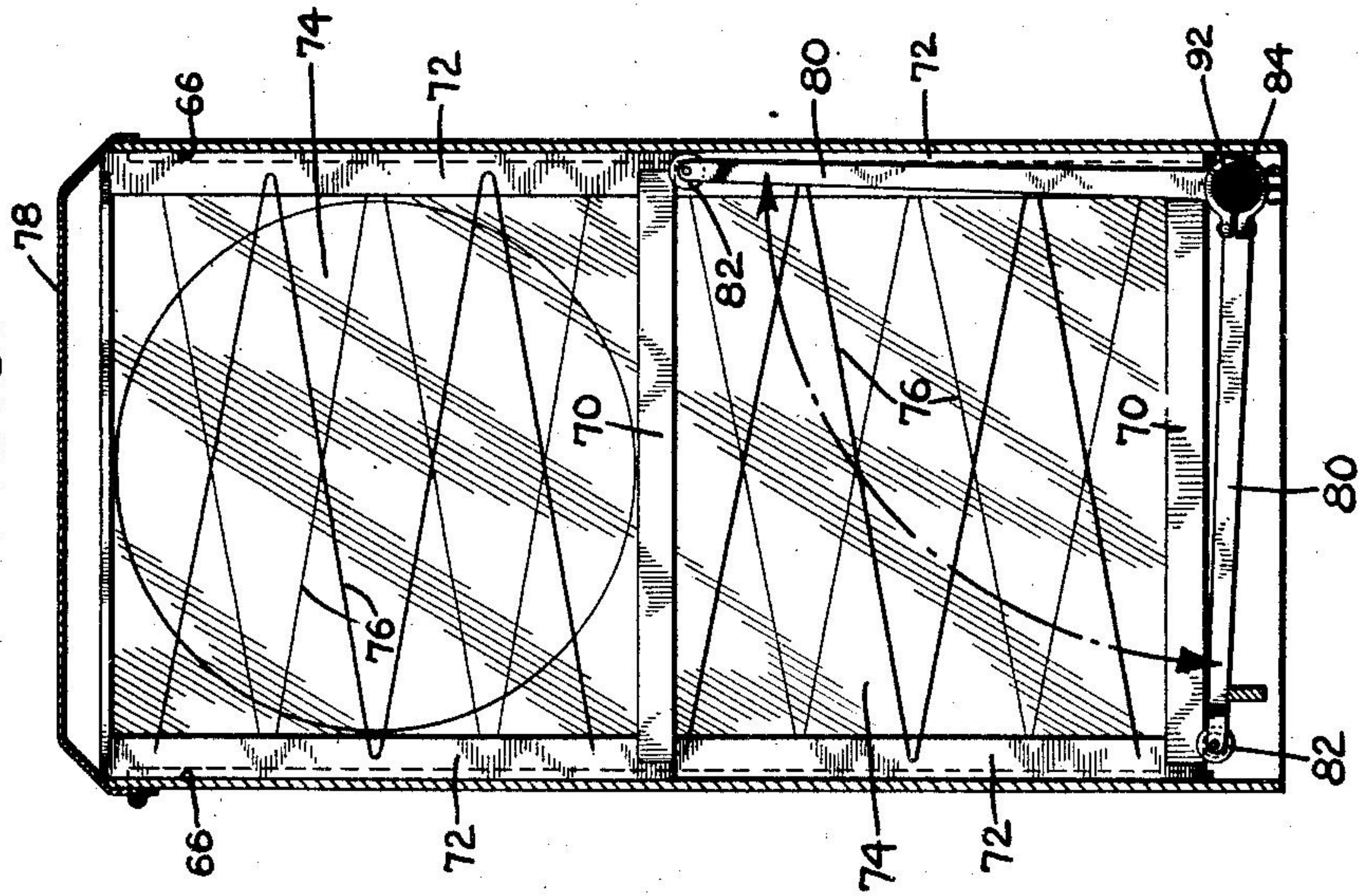
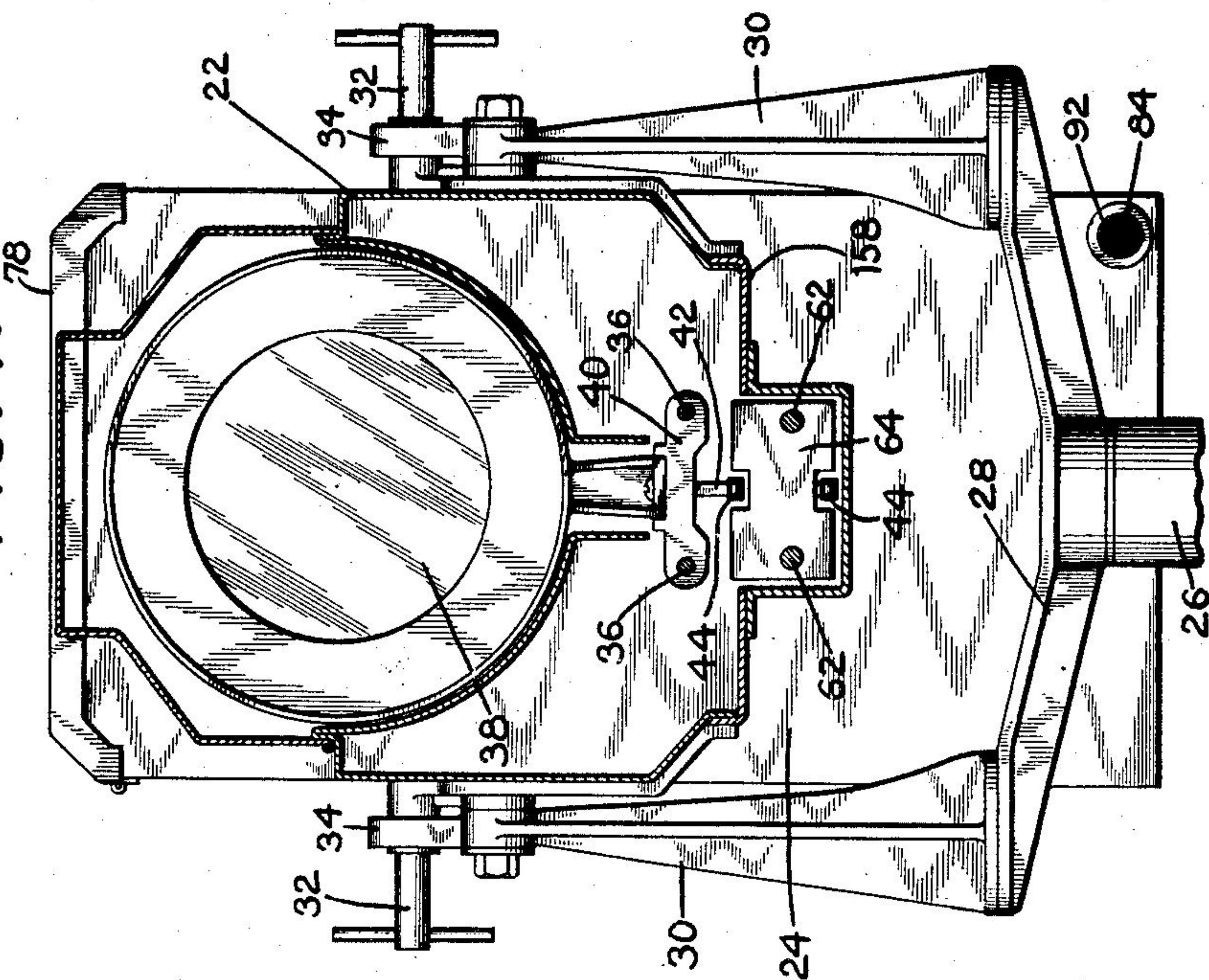

FIG. 4.



Inventors
H.A. KLIEGL
JOS. KLIEGL

By their Attorneys
Cooper, Kerr & Dunham